

Items Supplied >

1 – FRONT HEADPIPE AND HEATSHIELD
1 – REAR HEADPIPE COLLECTOR ASSEMBLY AND HEATSHIELD
1 – COLLECTOR HEATSHIELD
1 – BRACKET, FRONT HEADPIPE SUPPORT
1 – CLAMP, FRONT HEADPIPE SUPPORT
1 – CLAMP, 27-61 MSC
5 – CLAMP, HOSE HS-24
2 – CLAMP, HOSE HS-32
1 – FLOORBOARD MOUNT SPACER PLATE
1 – THICK 3/8" WASHER
1 – THIN 3/8" WASHER
1 – 3/8" X 1" CARRIAGE BOLT
1 – 3/8" NYLOCK NUT

Application(s) >

HARLEY:
DRESSER 17-18

Instruction Manual >

6451

Page 1 of 5

PRIOR TO INSTALLATION, MAKE SURE YOUR STOCK HEADPIPE GASKETS ARE IN GOOD CONDITION. IF YOU HAVE ANY DOUBTS AS TO THEIR CONDITION, REPLACE THEM.

*****NOTE: This system is equipped with extra O₂ sensor bungs (M18 X 1.5 threads) towards the front of the headpipes, nearest the cylinders, for aftermarket tuning purposes. DO NOT REMOVE the bung plugs unless installing extra O₂ sensors for tuning purposes.**

Read all instructions carefully and completely before installing your new exhaust system!

1. Remove the saddle bags, right side cover, and right front floorboard from the frame.
2. Unplug the O₂ sensors on the front and rear headpipes from the motorcycle wire harness.
3. Remove the stock exhaust system being careful not to damage the headpipe gaskets. If the headpipe gaskets are in good condition they do not need to be removed from the cylinders. Remove and save the flanges, nuts, retaining rings, muffler clamps, muffler mount bolts, and O₂ sensors from the stock exhaust. Also remove and discard the crossover bracket and bolts from under the bike. Label the O₂ sensors front and rear to ensure they will be installed on the proper headpipe.
4. Remove the stock exhaust mount bracket.
5. Install the supplied headpipe support bracket using the stock nut. See **FIGURE 1**. Lightly snug the nut but **DO NOT TIGHTEN** so the bracket can be adjusted. The bracket should be positioned at a slight angle. See **FIGURE 1**.

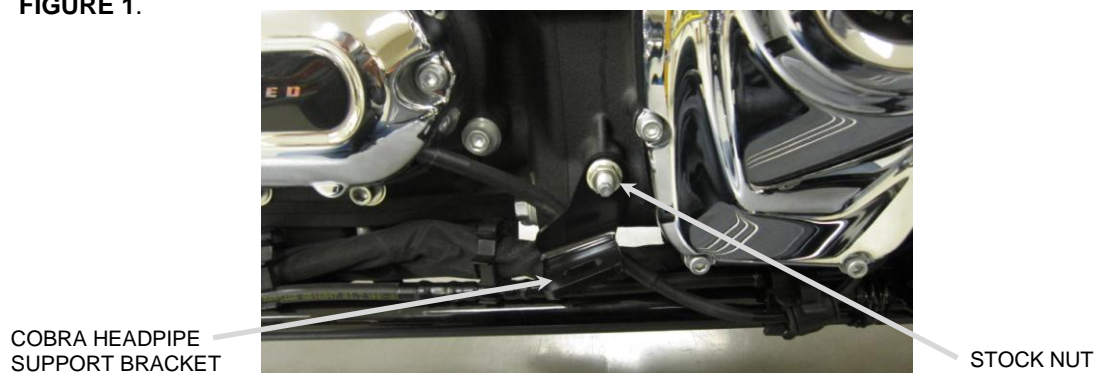
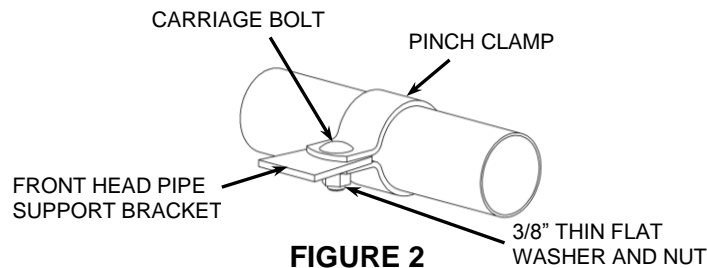

FIGURE 1

Continued on Page 2

DISCLAIMER: NOT LEGAL FOR SALE OR USE IN CALIFORNIA ON ANY POLLUTION CONTROLLED MOTOR VEHICLES.

6. Install the stock flanges, retaining rings and O₂ sensors onto the supplied front and rear headpipes. Be sure to install the front O₂ sensor on the front headpipe and the rear O₂ sensor on the rear headpipe. NOTE: the O₂ sensor with the long wire harness is the front O₂ sensor.
7. Install the front headpipe (with stock gasket in place) onto the front cylinder using the stock nuts. Snug the nuts but **DO NOT TIGHTEN** at this time.
8. Slide the supplied pinch clamp over the front headpipe making sure the square hole on the clamp is facing up and towards the inside. Position the clamp over the support bracket so that the pinch clamp captures both sides of the bracket. See **FIGURE 2**. Insert the supplied 3/8" carriage bolt through the top of the pinch clamp and support bracket. Install the 3/8" thin flat washer and nut onto the bottom of the carriage bolt but **DO NOT TIGHTEN** at this time. Leave the nut loose so the headpipe can be adjusted.



9. Position the supplied #27-61 MSC clamp onto the rear headpipe collector assembly inlet. The hex head of the clamp should be inward and down. See **FIGURE 3**. (NOTE: The clamp should be flush with the end of the inlet when tightened. See **FIGURE 3**. If the clamp is slid past the slots on the inlet the clamp will not tighten properly).

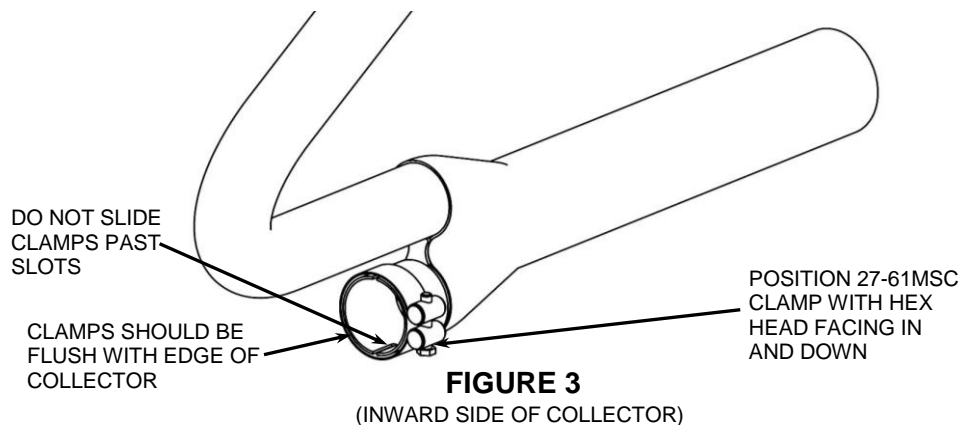

10. Install the rear headpipe collector assembly (with stock gasket in place) onto the rear cylinder and on to the front headpipe. Make sure the front headpipe is pushed in as far as possible into the rear headpipe collector assembly inlet. Use the stock nuts to fasten the headpipe to the cylinder. Snug the nuts but **DO NOT TIGHTEN** at this time. See **FIGURE 4**.

Continued on Page 3

NOTE: Arrows point to the position of the hex head of the clamps.



REAR HEADPIPE COLLECTOR ASSEMBLY

27-61 MSC CLAMP

FIGURE 4

FRONT HEADPIPE SUPPORT

11. Position the stock right side muffler clamp with hex nut facing inward and down as shown in **FIGURE 5** and slide it onto the muffler assembly inlet tube. (NOTE: The muffler clamp should be flush with the end of the muffler when tightened. See **FIGURE 5**. If the muffler clamp is slid forward past the slots on the slip collar the clamp will not tighten the muffler properly. Also, make sure the clamp spacer is not over the slots. The slots need to be covered by the clamp band so that it seals the slots properly. Rotate the clamp if necessary.)
12. Slide the muffler assembly onto the rear headpipe collector outlet. Secure the muffler assembly to the stock sliding hanger on the frame using the stock bolts and tighten to factory specifications. Adjust the muffler fore and aft so that the stock slider is centered in the rubber mount. Then rotate the muffler around the axis of the collector so the muffler is hanging straight down from the rubber mount while being viewed from the back of the motorcycle. When the muffler is positioned correctly then tighten the muffler clamp. See **FIGURE 6**.

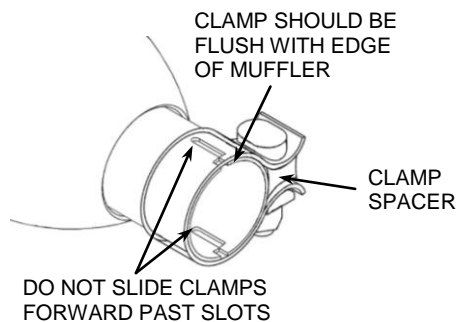

FIGURE 5

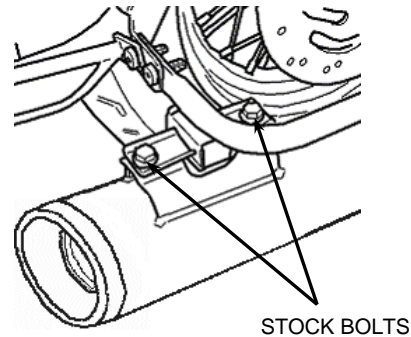

FIGURE 6

13. Make sure the rear muffler assembly, 2 into 1 collector, and headpipes are straight and parallel to one another. Look at the headpipes from the side of the bike and be sure the headpipes are parallel in the horizontal direction to one another where they enter the 2 into 1 collector. Look at the headpipes from the top of the bike and be sure that the rear headpipe is straight in line with the front headpipe. If the headpipes are not aligned properly then the front and rear heatshields may not align properly with the collector heatshield.

Continued on Page 4

14. When the system is straight, tighten in the following order; headpipe flanges to the cylinders (slowly tightening opposing nuts), 2 into 1 collector clamp (27-61 MSC), and finally the front headpipe support clamp. (NOTE: The clamps should be flush with the end of the muffler or collector when tightened. See **FIGURE 3 & 5**. If the clamps are slid past the slots on the muffler inlet or the collector inlet the clamps will not tighten properly).
15. Plug the O₂ sensors back into the motorcycle wire harness and route the wires away from the exhaust in the same manner as stock.
16. Remove the heatshields and hose clamps from packaging. Unscrew the hose clamps and feed the tail end of the clamps through the clips on the inside of the heatshield so the screws are accessible with a screwdriver once the heatshield is installed. The large HS-32 hose clamps go in the clips on the collector heatshield. See **FIGURE 7** for proper positioning of the clamps on the heatshields. (NOTE: **The arrows point to the positioning of the hex head of the clamps.** The hex head of the clamps should be accessible for tightening but not visible when the heatshields are mounted to the pipes.)
17. Install the right rear heatshield over the rear headpipe. (Hint: Spread the hose clamps apart slightly to make it easier to slide them over the headpipes.) Snug the clamps but **DO NOT TIGHTEN** at this time. See **FIGURE 7**.
18. Install the right front heatshield over the right front headpipe. (Hint: Spread the hose clamps apart slightly to make it easier to slide them over the headpipes. When the heatshield is aligned properly snug the clamps but **DO NOT TIGHTEN** at this time. See **FIGURE 7**.)
17. Install the collector heatshield over the collector by first sliding the front of the collector heatshield forward over the front and rear headpipe heatshields and then back to align it with the muffler body. The front of the collector heatshield will go over the rear portion of the headpipe heatshields. Adjust the heatshield fore and aft on the collector so there is a small and even gap between the rear of the collector heatshield and the front of the muffler body. Also be sure to rotate the front of the collector heatshield on the collector so that it sits on both the front and rear headpipe heatshields evenly. See **FIGURE 7**. NOTE: The headpipe heatshields may need to be adjusted fore and aft and or rotated on the headpipes to allow the collector heatshield to align properly. When the heatshield is aligned properly snug the clamps but **DO NOT TIGHTEN** at this time.

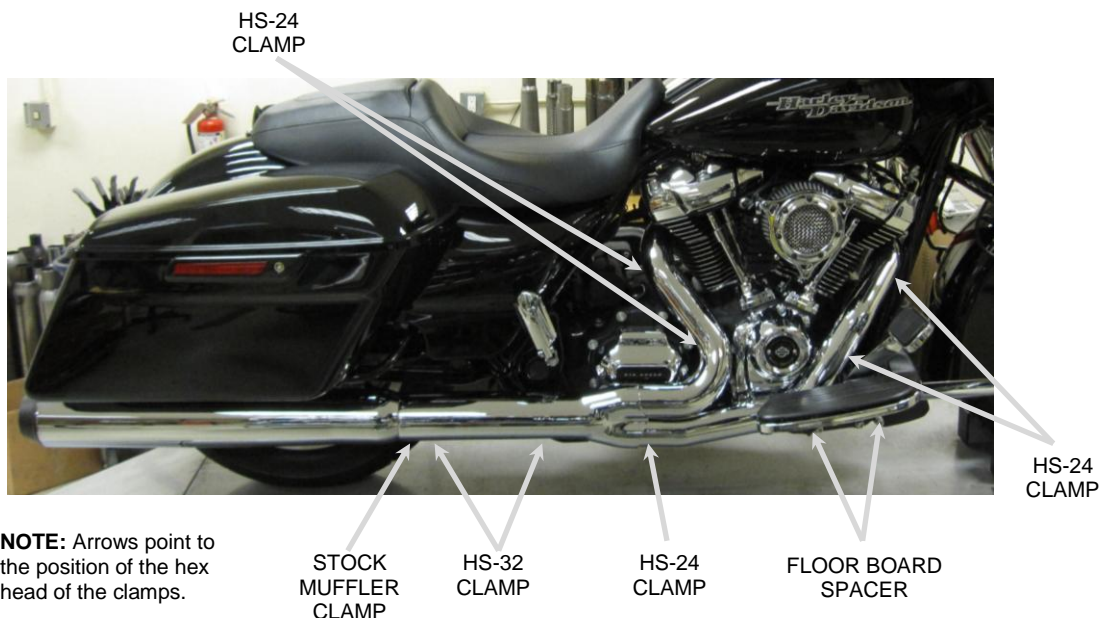
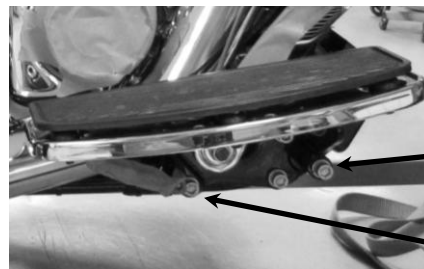

FIGURE 7
Continued on Page 5

18. When the heatshields are aligned properly, tighten the clamps on the front and rear heatshields first. Then tighten the collector heatshield clamps last. See **FIGURE 7**.
19. Insert the supplied floorboard spacer plate between the rear floorboard mount and the frame, then align the dowel pin and reinstall the allen bolt. Tighten to factory specifications. See **FIGURE 8**.
20. Remove the allen bolt from the right front floorboard mount. Place the supplied thick washer between the front floorboard mount and the frame. Reinstall and tighten the allen bolt to factory specifications. See **FIGURE 8**.



INSTALL THICK 3/8"
FLAT WASHER ON
FRONT MOUNT

INSTALL SPACER
PLATE ON REAR
MOUNT

FIGURE 8

21. Reinstall any other previously removed items. Tighten to factory specifications.
22. Make sure all the hardware (brackets, headpipes, heatshields, mufflers and floorboards) have been tightened appropriately.
23. **IMPORTANT: Before starting your engine remove all fingerprints from chrome with a quality wax or chrome polish. Failure to do so can cause chrome discoloration. Due to fluctuations in fuel delivery settings, timing, etc., Cobra Engineering does not warrant against chrome discoloration. Clean the black exhaust tip with a mild dishwashing soap and a soft cloth. Avoid abrasive cleaning methods such as granular or dry cleansers, simple green, scotch-brite or steel wool pads. Abrasives may breach the coating and shorten life.**

IMPORTANT: If your motorcycle is equipped with fuel injection it is recommended that you install a Cobra Fi2000® Digital Fuel Processor with your Cobra exhaust system, (Cobra Part#: 692-1631CL or 692-1631B).

DISCLAIMER: NOT LEGAL FOR SALE OR USE IN CALIFORNIA ON ANY POLLUTION CONTROLLED MOTOR VEHICLES.